

Varenummer: 20955503
 Beskrivelse: E+G Justerfod
 GN 342.1-60-M16-SV

Mål

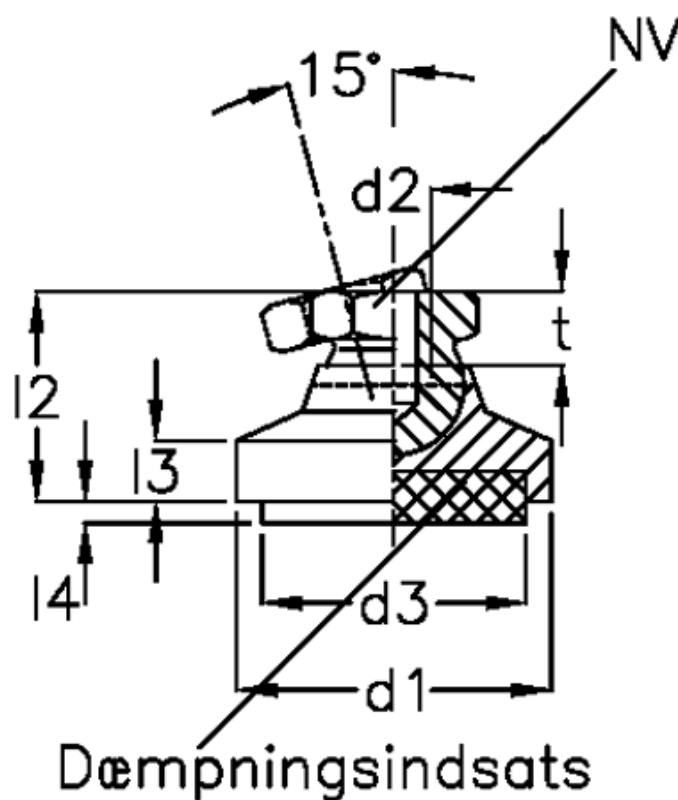

Area(m ²) damping insert	= 2641	l4 compression 0,6 N/mm ²	= 4.9
d1	= 60	Load (N) by compression 0,4 N/mm ²	= 1050
d2	= M16	t	= 16.0
d3	= 58		
l2	= 38.5		
l3	= 11.0		
l4 compression 0 N/mm ²	= 7.0		
l4 compression 0,4 N/mm ²	= 5.8		